



SAITO FG-60R3

4-Stroke Gasoline radial Engine Operating instructions

Thanks for buying SAITO FG-60R3 4-stroke gas-engine exclusively for model planes.

In order to avoid misuse, please be sure to read well this instruction manual carefully. If there should be any deficiency, inconvenience, etc. Concerning the manufacture, our company will repair them with responsibility.

Any failure or trouble caused by unnecessary disassembly, modification, or other uses than those provided in the instruction manual is not subject to the warranty, however.

Moreover, all responsibilities for the use of the engine, and other obligations and responsibilities based on laws, regulations, etc. are borne by the purchaser and the user, and SAITO SEISAKUSHO CO., LTD. is exempt from any responsibilities.

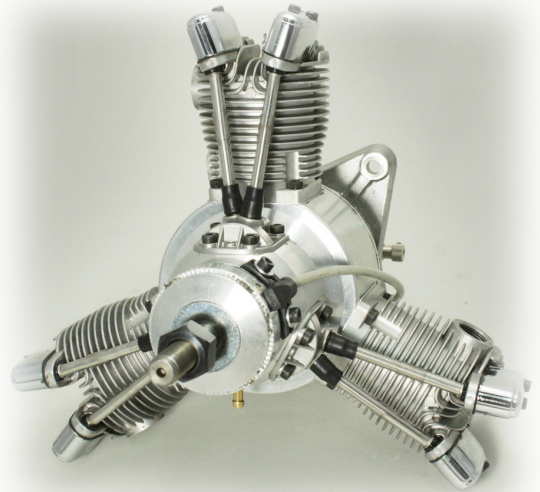

Specifications

Bore	Ø32.0mm x 3	Stroke	25.0mm x 3	Disp.	60.32cc
Weight (Approx.)	Body: 1,800g / Mufflers: 90g / Ignition system: 195g				
Practical speed	Approx. 1,500-7,000rpm	Max on GND	Approx. 6,000-7,000rpm		
Propeller	D21" x P10" ~D23" x P8"	Static thrust	Approx. 7kgf (Depend on prop)		
Fuel	Regular gasoline: Oil=20:1 (Volume ratio)		Applications	2st Gas-engine 50cc class	
Fuel consumption	Approx. 30cc/min (At full throttle 6,500rpm) *Fuel flow varies depends upon prop load. More fuel flow with larger load and less fuel flow with smaller load.				
Battery for ignition system	Voltage: 6-9V higher than 1,000mA is recommended				
Standard accessories	Limit gauge (0.1t) for tappet adjustment	1pc	Spanner for tappet adjusting lock nut	1pc	
	Plug wrench	1pc	Hexagonal wrench 1.5mm	1pc	
	Spark plug [SP-2] (Attached to the engine)	3pcs	Ignition system (w/ sensor)	1set	
	Muffler set (3 Flexible mufflers & Bracket)	1set	Stand off mount 39.5mm	4pcs	

Outside dimensions

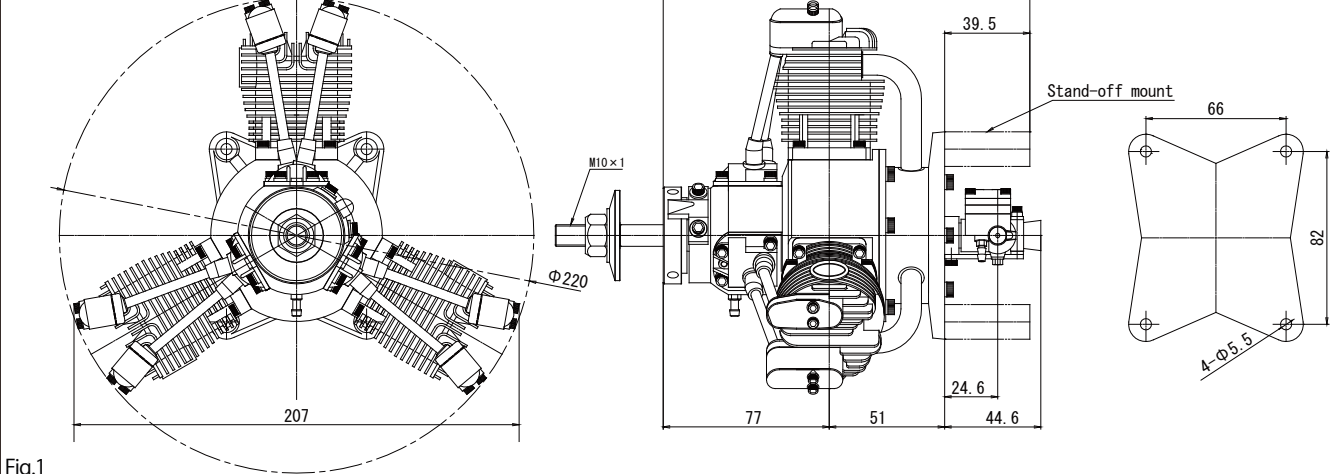

Fig.1

NOTE&CAUTION

- Please note that we take no responsibility for any accidents, health damages, etc. using engine / fuel.
- If there's anyone stand in front of the engine, be sure to have them move behind the plane before starting the engine.
- Be sure not to breathe the evaporative emission of fuel and exhaust smoke as possible since they have harmful effects on human body.
- Once the engine starts, move behind the plane and keep your arm holding the plane away from the prop.
- Make needle adjustment or other control from rear of the engine.
- If the plane cannot be fixed, ask your assistant to hold it for safety.
- During early stage of using engine, take the height in the air high enough to land safely in case the engine stop in the air suddenly. It will reduce the risk of crash or landing accident.
- Take an extreme care for not bothering or injure others when operating the engine or flying.
- An engine for a model plane is not a toy. Handle it with an extreme care.
- Please note that our guarantee will not cover any breakage or trouble on the engine caused by user's disassembling, modification, incorrect handling, and so on.

1. Propeller

- The Standard prop is Mezik D22"xP10" which brings approx. 6,400rpm
- Depending on the airframe, please adopt the adequate size in the range of 5,800~7,000rpm from reliable products generally on the market.
- Since an imbalanced prop is vibratory and dangerous, please maintain balance with a balancer.
- A cracked prop should never be used. Make sure to check any time and replace it with a new one if it's cracked.
- Never use too low load prop as it leads large vibration and may result in engine failure or accident.
- Tighten up the prop nut after every flight. Especially a wooden prop tends to compressed so take care of its looseness.

2. Fuel, tank, piping

- Since gasoline is dangerous material, be careful of its storage, use, and transport enough.
- Unleaded high-octane gasoline is not required for SAITO engine.
- The fuel is mixture of commercial regular gasoline and reliable oil for 2-stroke engines.
- [Example of oil recommendation]
 - Klotz KL-200 Original Techniplate
 - Deluxe Materials PowerModel 2T-S etc.
- Lubrication for piston, connecting rod, bearing or cam gear is a blow-by lubrication in which the oil in the fuel goes into the crankcase from the clearance between the cylinder and piston. Therefore the engine life is affected by the property of the fuel oil. Please use the oil of reliable quality.
- Please be sure to use the mixture "gasoline : oil = 15~20 : 1" by volume ratio. (Ex. 1000ml of gasoline should be mixed with more than 50ml of oil).
- Any damage caused by the fuel used, in which the oil ratio is lower than 20:1 ratio, is not warranted.
- Please use pure gasoline** as long as possible. In some areas in the world, standard gasoline contains specific amount of ethanol. Such fuel may cause not only power loss but also corrosion inside the crankcase.
- If you can't get pure gasoline for the engine, please make sure to follow the procedure below after the last operation of the day; to remove the blow-by gas from the crankcase and prevent the engine from corrosion.
 - 1) Stop the engine by fuel cut to burn out the fuel in the carburetor.
 - 2) Remove the remaining fuel from the tank.
 - 3) Turn off the switch of the Ignition.
 - 4) Open the throttle.
 - 5) Apply an electric starter to the prop to run without fire for about 10 sec.
- Make sure to use "gasoline-proof" products for the tank, lid rubber, piping, and tubing. Some of the products for glow fuel can't be used for gasoline.
- Use the gasoline proof tank which has adequate capacity (Approx. "Fuel consumption x Flight duration + 100~200cc).
- The carburetor has a pump but its pumping pressure is not so strong. Place the tank as close to the carb as possible.
- Set the tank in order to make the fuel level slightly lower than the center of the carb.
- Since commercial gasoline contains many impurities, please be sure to use a reliable filter for the admission port of the gasoline-proof fuel pump (Fig.2) and in the fuel tank as well (Fig.3).
- Without using filters, proper performance of the carburetor is not delivered, resulting in failures.
- Provide "Fuel feeding pipe", "Carb feeding pipe", and "Air inhalation pipe" separately (Fig.3).
- When provide "Air inhalation pipe" as Fig.4, arrange the tube above the fuel level to avoid overflow.
- Please check carefully if there's any crack on the piping, tubing, connection, and tank. (If there's any leakages, not only the performance of the engine decreases dramatically but also there is danger of fire.)
- All of the connection parts should be bound by thin Nylon strap or wire to avoid fuel leakage or air induction to the fuel line.

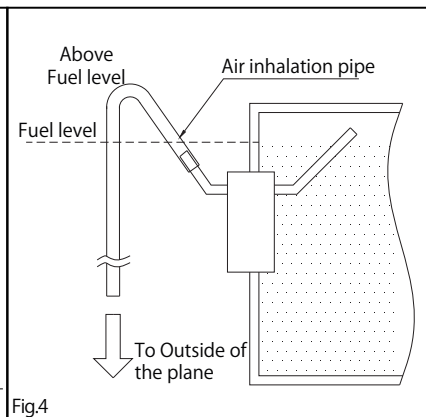
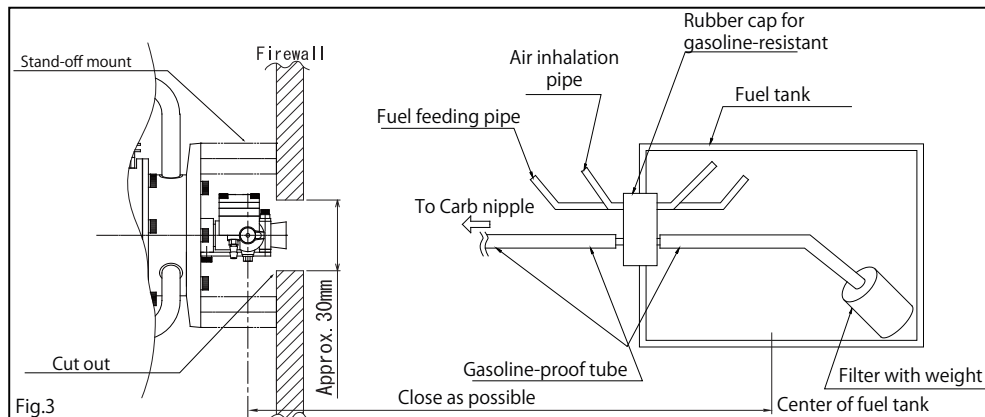
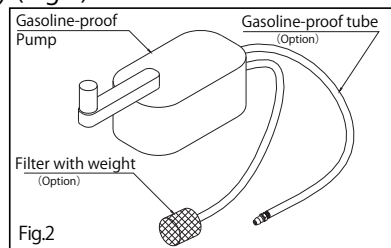

3. Ignition system

- The ignition system develops extremely high voltage. Do not touch it during operation.
- Use a plastic clip to hold the connectors and spiral tube to protect each wire of the ignition system.
- Isolate the ignition system completely from the receiver, servos, and batteries to avoid a radio-interference trouble.

- Each switch (for Ignition and for Receiver) should be isolated and set far from each other.
- A gas-engine generates noise which has an adverse effect on RC equipment. Carry out a noise check each time while the engine is running before flight. As a simple method, after starting engine you can check operating it about 50m away from the plane. If there is no malfunction, it is safe.
- Charge the battery for the ignition system and RC device fully.
- The function of each cord;

(1) Plug cord (meshed high tension cord)

As Fig.6 shows there are three cords for three cylinders. Make sure to attach each number indicated on the main unit to each cylinder (Refer to Fig.5 regarding cylinder number). When you put on the plug cap, insert deep into the plug to avoid coming off during flight. And then pull the plug cap to confirm that it won't come off.

(2) Sensor cord (Gray cord with exclusive connector)

Connect with the cord from the sensor attached to the engine.

(3) Battery cord (black/red cord)

Please use the fully charged battery that has adequate spec. (6-9V, more than 1000mA is recommended.). Between the battery and main unit, make sure to set a heavy duty switch whose capacity is higher than 3A.

(4) Tachometer cord (black/red/white cord)

Connect the digital tachometer (Option). Otherwise the connector is normally vacant.

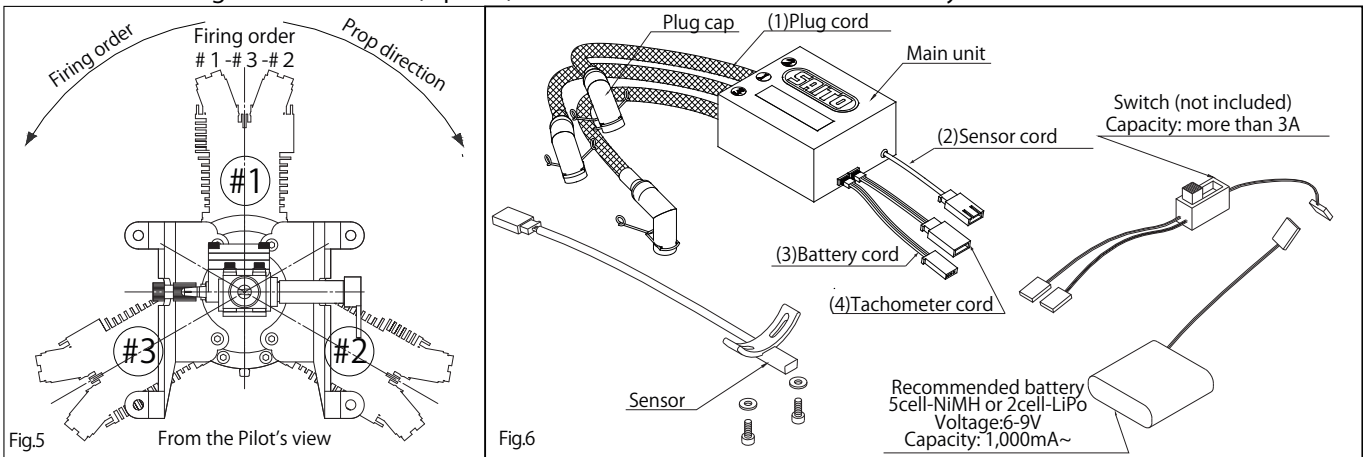

4. Spark plug

- UNEF1/4-32mm spark plug (SP-2) is the standard equipment.
- Attach the plug cap from the ignition system to each cap and insert the clip into the groove on the plug.
- Set the numbers of flights by yourself to replace the spark plug.
- Replace the plug to a new one when you flighted as many as above. (A spark plug is consumable.)

5. Engine Installation

- As the carburetor comes out from back of the firewall, cut out the firewall as adequate size referring to Fig.3.
- Sometimes fuel get flown back from carburetor and may spatter inside the firewall. For that case, make sure to cover the batteries, RC equipment and all the foam members with gasoline-proof material.
- Make the firewall robust enough to endure vibration and torque.
- It is preferable to apply some adhesives (such as screw lock) on the tip of each cap screw to avoid looseness when you install the engine.
- Take special care for cooling engine as insufficient cooling causes engine trouble such as overheat, percolation, or muffler looseness.
- To ensure cool wind passes through the engine, the cowling should be devised. Building some baffles inside the cowling is highly recommended for efficient cooling.(Fig.7)
- Make the air flow outlet area about 3-times larger than the inlet area.
- The mufflers should be securely inserted deeply into the adopter and tightened up using spanners.
- Make sure to fix the outlet of the flexible mufflers outside of the cowling using the attached bracket.
- To dispose of dirty oil from the breather, attach the gasoline proof tube to the breather nipple and fix the other side of the tube on outside of the cowling. (Fig.8)

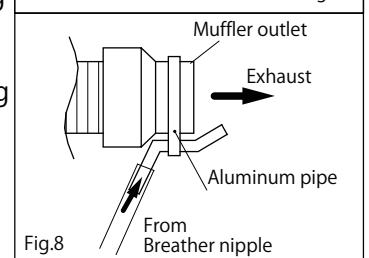
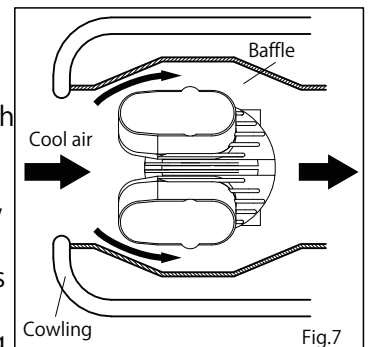

6. Carburetor

- As to both needles, turn to CW, the fuel will become leaner and the rotation speed will increase.
Turn in CCW, the fuel will become richer and the rotation speed will decrease.

Main needle: To adjust the speed at the time of full open of the throttle.

Slow needle: To adjust the speed from the idling to the middle speed.

- Both needles are interfered slightly from each other so confirm the balance of peak and response after adjustment.

- Since a gas-engine has narrow range of air-fuel ratio, adjustment of the needles is severer than a glow-engine.
- The carburetor for the gasoline engine is the assembly of very strict and delicate parts. Make sure to use filtered gasoline.
- **Do not disassemble the carb by yourself.** If you need to clean up the carb or there's any troubles regarding carb, please consult the shop which you bought the engine from before disassembling.

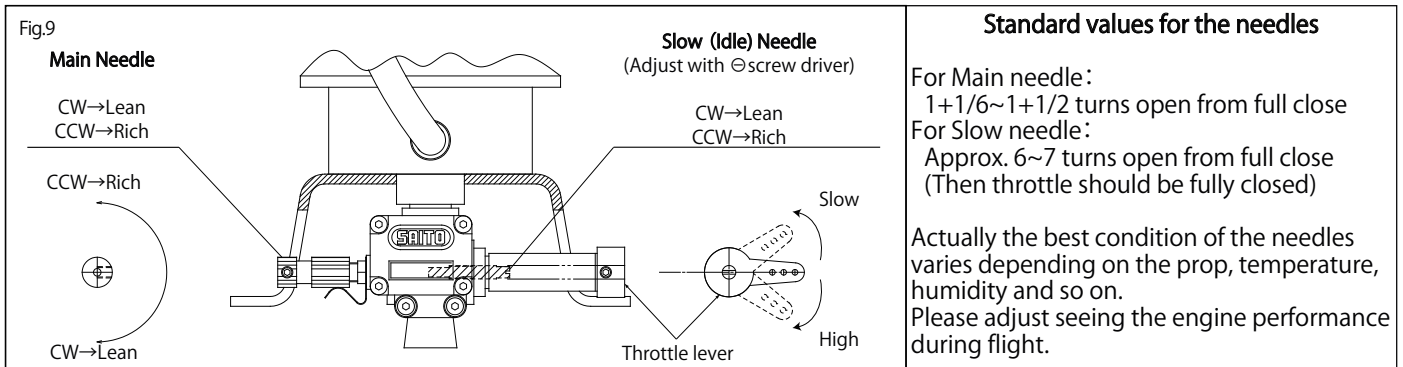

7. Preparation for engine start

- Mount the engine on a robust and parallelized test bench or on the plane. (Either way, the engine should be fixed and immobile.)
- Check whether the throttle can be fully closed and opened certainly.
- Check whether each code of the ignition system is connected certainly.
- Use about 1000cc tank for the test bench, or a tank which has appropriate capacity for the plane.
- Fill up the tank with the fuel mixture of "gasoline : oil" = "15~20 : 1".
- Attach a well balanced D21" x P10" ~D23" x P8" prop to the engine shaft.
- To start with an electric starter, attach a spinner to the end of the shaft.
- To see the peak condition clearly, use a tachometer. It will prevent over-throttling or overheat. You can also use the digital tachometer (Option).
- To check discharge from the breather, attach a gasoline-proof transparent tube to the breather nipple.

8. Break-in

- As Break-in is an important procedure not only to pull out the maximum performance of the engine, but also to prevent the engine from overheat in the early stage of operation, it must be cautiously done.
- The purpose of break-in is initial lubrication and adjusting of the mobile parts under the condition of rich fuel mixture.
- **Never make the fuel mixture lean** during Break-in. It could cause seizure even during idling or low speed running.

- Be sure to turn off the switch of the ignition system until just before trying to start up the engine.
- After turning on the transmitter switch, turn on the receiver switch.
- Check if the throttle and other servos move properly.
- Open the main needle about 2 turns from full close.
- Power on the ignition system.
- Open the throttle about 1/4 from full close.
- Starting with excessively opened throttle is dangerous since the plane jumps forward.
- Apply the electric starter to the prop and activate for about 5-10 seconds to start the engine.
- If the engine doesn't start up, open the main needle 1 turn more and apply the starter again.
- Once the engine starts run it for about 10 sec in low speed.
- Open the throttle fully and open the main needle until the speed drops just before engine stops. (Ref. Under approx 4,000rpm at full throttle.)
- If the fuel mixture doesn't become rich and speed doesn't decrease, open the slow needle too.
- Then continue running for 2 tanks under the same condition.
- During this initial operation, contact of each part inside the engine will be matched. So make the fuel mixture as rich as the engine doesn't stop. Do not care about running smoothness at this step.
- Refill the tank and start up the engine again.
- Open the throttle fully and turn the main needle to achieve peak and less speed (richer) alternately about 5 times.
- Maintain the peak condition long gradually.
- When the peak gets stable, operate the throttle to vary from slow to high speed several times to check the response.
- After that run it for 2-3 minutes keeping high speed.
- When it comes to run smoothly at peak, break-in on the ground is completed.
- Fly it for about 20 times in rich condition to complete break-in in the air.
- After break-in, please run the engine in slightly rich condition as long as it doesn't affect to the flight.
- Tighten up the whole screws and adjust the tappet gap as discussed later.

9. Needle adjustment

- Before adjust the needles please set both needles as the standard values.
- In principle, the carburetor should first achieve peak by adjusting the main needle.

- Unless the peak is certainly achieved, idle adjustment will be difficult and not stabilized.
- Start up the engine and run for 1 minute in rich condition. Then fully open the throttle.
- By turning the main needle CW, observing tachometer and exhaust sound, achieve peak carefully.
- Operate the throttle to low until the engine runs stably with an idle speed around 1,500rpm by adjusting the slow needle with a \ominus screw driver carefully.
- Once idle speed is set, open the throttle to full gradually. If the speed becomes slow or goes up suddenly, adjust the slow needle carefully until the speed rises linearly from idling to peak by fine-tuning.
- After that perform the process from idling to peak quickly. If the speed rises non-linearly, fine tune the main needle.
- If the speed around slow-mid range gets cough or hesitating, fine tune the slow needle and check the response as well. Repeat this fine-tuning and response check carefully until the response improves.
- Carb adjustment is affected by many factors such as prop, flight style, humidity, temperature, atmosphere, oil, plug, fuel, and so on. Please keep trying to find the best condition to match your plane.
- The best richness of the air-fuel mixture at slow speed depends on the flight style. Generally, Scale flight requires stability in low speed so slightly lean condition is preferable. Acrobatic flight requires quick response from low through high, so slightly rich condition is preferable.
- Tip for adjustment of the slow needle is to make it as lean as the engine doesn't get stole when open the throttle quickly.
- To keep the engine life longer, adjust the main needle as rich as possible in the range it doesn't affect to the running.
- Since over throttling of the main needle leads to knocking or overheat and has an adverse effect on the connecting rod and cam gear, adjust a little richer than peak.
- Once you notice abnormal vibration or sound during throttling the main needle, just return to open the needle immediately.
- Where the plane achieves peak completely at the attitude of ascent should be a proper peak of the engine during flight.

10. Tappet adjustment

- After completing ground break-in or operating the engine for 1 hour, adjust tappet gaps (valve clearances) by following procedure to compensate initial wearing, while the engine is cold.
- #1 cylinder should be adjusted first, next #3, finally #2 cylinder should follow in order by the same procedure.
- Remove the spark plug and rocker covers from the #1 cylinder.
- If the attached gauge (limit gauge, $t=0.1\text{mm}$) comes to be inserted, gap has been enlarged beyond the allowable limit.
- Turn the prop slowly forward by hand until the rocker arm of intake stops. Further turn the prop to bring the piston to the TDC (Top Dead Center) of compression stroke.
- Use the attached wrench and hexagonal wrench to adjust the gaps indefinitely close to zero.
- After adjustment, put on the spark plug and turn the prop forward to check if the compression is enough.
- If the gap is lower than 0, the valve is opened all the time so the compression is not generated (then, loosen the screw to reset).
- If the gap is correct and compression is enough, securely tighten (but not excessively) the lock nut.
- Do the same adjustment for the #3 - #2 cylinders in order.
- For SAITO engines, the tappet gap is enlarged during operation due to thermal expansion of the cylinder (made of aluminum). Therefore set the gap indefinitely close to zero when the engine is cold.
- As tappet gap is one of the most important factors in the maintenance of 4-stroke engines, occasionally check it.

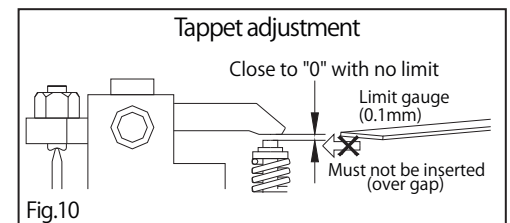

11. Other

- During operation, the screws all over the engine can be loosen by heat expansion of metal. So please tighten up them occasionally.
- Just after start up the engine, perform warm up running in rich condition for about 1 minute, and just before stop run it at idling for 1 minute to cool down as well.
- When stop the engine after the final flight of the day, be sure to stop by cutting fuel to remove fuel from the carburetor. And remove the fuel from the tank and reserve it with special care.
- When the exhaust valve gets dull by carbon or sludge especially in cold atmosphere, remove the rocker cover and apply some anti-rust spray to the exhaust valve to help the valve to move smoothly.
- Never use anti-rust spray that contains organic solvent which degrades rubber seals inside the engine.
- Sometimes the oil oozes from each joint or commissure however it's no problem on performance.
- Notes for purchasing parts: Please give orders to the shop you purchased from with "Engine model", "Part No. or part name", and "Quantity".

Optional parts

- Filter with weight [G36-154]
- Spark plug SP-2 [G60R3-120]
- Tappet adjusting kit [30-161]
- Rubber tube for gasoline(1m) [G36-155]
- Aluminum spinner nut [57T-30]
- Digital tachometer [G17-167]

フレキシブルエキゾーストパイプの接続について

- ① 写真を参考に、下の組み合わせで各シリンダーとエキゾーストパイプを接続します。

接続ナットは、各パイプが回転する程度に仮止めしておきます。

- #1シリンダー → 最長のパイプ
- #2シリンダー → 最短のパイプ
- #3シリンダー → 中サイズのパイプ

- ② ブラケットとM3ボルト、ナットで、排気端を絞り込むようにまとめます。仮止めに、一部紐で束ねておくとブラケットでまとめ易くなります。

- ④ 各シリンダーの接続ナットを本締めします。

- エキゾーストパイプと防火壁、インテークパイプが接触しないように固定して下さい。
- 下の写真を参考に、パイプの曲げがきつくなり過ぎないように取り付けて下さい。
- 曲がりのきつい箇所は、排気熱の高温により破損する可能性があります。

How to Fix the flexible exhaust pipes

- ① Referring to the picture, insert the exhaust pipes to the cylinders as following pairs.

At this step, leave the bushing nuts temporary fixed to allow the pipes to turn.

- #1Cylinder → Longest pipe
- #2Cylinder → Shortest pipe
- #3Cylinder → Middle pipe

- ② Fix the ends of the pipes with the bracket , M3 screw and nut. Temporary binding the pipes with a band will help to fix the bracket.

- ④ Finally tighten the bushing nuts to fix the pipes completely.

- Fix the pipes not to touch the firewall and the intake pipes.
- Referring to the picture below, attach the pipes without too much bent.
- Too much bent causes not only power loss but also break due to heat from exhaust.

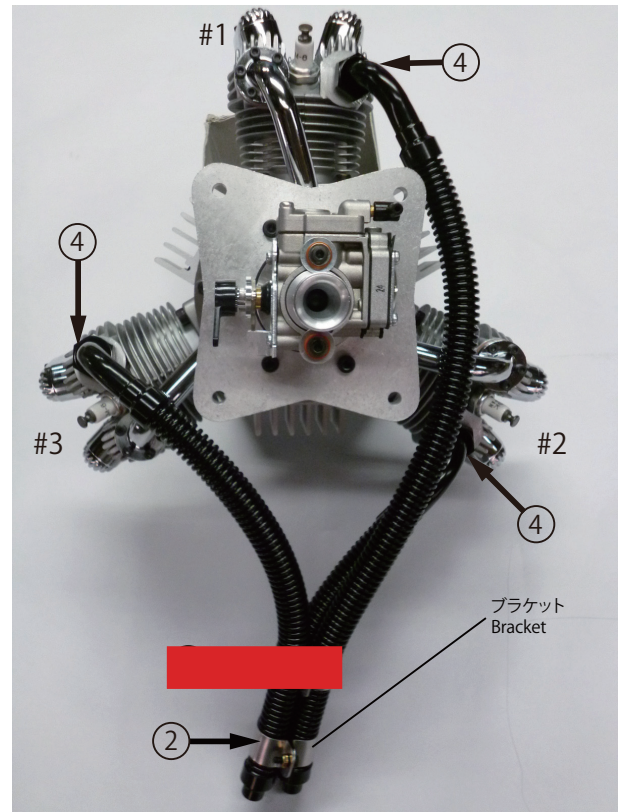

※写真はFG-84R3ですが、方法は同じです。

※Though the above sample picture is FG-84R3, the procedure is just the same.

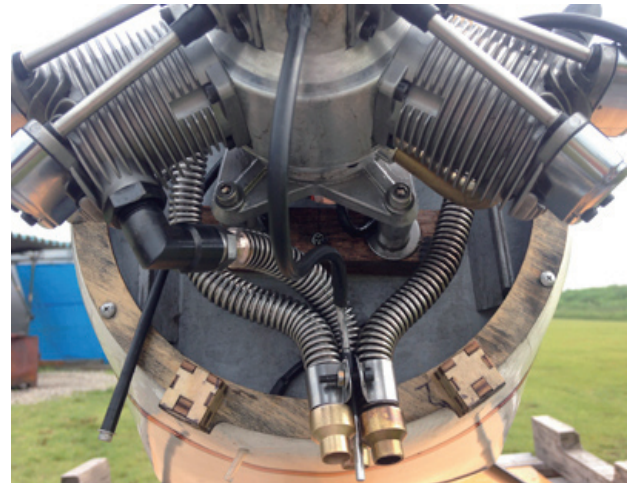

All specifications and models are subject to change without notice.



<http://www.saito-mfg.com>

SAITO SEISAKUSHO, CO., LTD.

22-7, 3-chome, Tokagi, Ichikawa-shi, Chiba prefecture 272-0024, Japan
Phone: 047-378-4156 FAX: 047-378-4155

SAITO FG-60R3 Parts List

No.	Item	Qty	No.	Item	Qty
01	Cylinder	3	46	Valve set (In & Ex) 46-1,-2	3set
06	Piston	3	47	Valve spring & Keeper & Retainer 47-1,-2,48	6ea.
07	Piston pin	3	48	Valve retainer (Cotter)	6
08	Piston pin retainer	6	49	Rocker arm cover	6
09	Piston ring	3	69	Intake pipe	3
10	Master rod	1	78	Muffler complete 78-1,-2,-3,-5,-6	1set
11	Linked conrod	2	82-1	Carburetor complete	1set
12	Conrod linkpin & E-ring 12-1L,-2	1set		Carburetor body assembly	1set
14	Cylinder screw set 14-1,-2	3set	83-1	31-6,82-1-1,-1-2,-1-3,-1-4,-1-7,-1-8,-1-13, -1-14,-1-15,-1-27,-1-28,-1-29,-1-31,91-1	1set
15	Crankcase	1	85	Main needle 85,90-1	1
17	Rear cover A (Intake manifold)	1	87	Throttle barrel assembly 82-1-5,-1-9,-1-16,88B,89,90-1	1set
18	Rear cover B	1	88B	Throttle lever 88B,90-1	1
19	Breather nipple	1	89	Slow needle	1
20	Front ball bearing	1	90	Carburetor screw & spring set 82-1-7,-1-8,-1-13,-1-16,-1-17,-1-26,-1-28, 90-1,31-6	1set
21	Main ball bearing	1	91	Carburetor gasket set 82-1-9,-1-14,-1-18,-1-20,-1-22,-1-31,90-1	1set
23	Crankshaft	1	95	Engine mount set 95-1,-2,-3,-4	1set
27	Taper collet & Drive flange 27-1,-2	1ea.	110	Anti loosening nut	1
28	Prop washer & Nut 28-1,-2,-3	1ea.	120	Spark plug	3
31	Crankcase screw set 31-1,-2,-3,-4,-5,-6	1set	121C	Master rod retainer (Crank pin plug)	1
32	Engine gasket set 32-1,-2,-3,-4,-5,-6	1set	131	Throttle valve extension adapter / set screw	1
33	Cam gear housing	3	152	Screw-pin	1
35	Cam gear	3	153	Electronic ignition system 153-1,-2,-3,-4	1set
36	Cam gear shaft	3	160	Pump assembly 82-1-17,-1-18,-1-19,-1-20,-1-21,-1-22,-1-23, -1-24,-1-25,-1-26	1set
37	Steel washer set	3set			
38	Tappet	6			
39	Pushrod	6			
40	Pushrod cover & Rubber seal 40-1,-2,-3	6ea.			
41	Rocker arm	6			
42	Rocker arm screw & Nut 42-1,42-2	6ea.			
43	Rocker arm pin	6			

